

ROBOT SERIES
RXL 01





Ürün Bilgisi / Product Information

Boyutlar / Dimensions : 8,55 x 6,0 x 6,15m
(L x W x H)

Yaş Grubu / Age Group : 3+

Oyun Kapasitesi / Capacity : 28

Düşme Yüksekliği / Fall Height : 1,0 m

Güvenlik Alanı / Safety Area : 93,7 m²





ROBOT SERIES

RXL 01



Metal parts are comprised of ST 37 Steel with a 3-step metal finish. Sandblasting and solvent-free zinc primer coating and electrostatic powder paint application is inherently corrosion resistant under extreme weather conditions and UV.

Metal parçalar, 3 aşamalı metal kaplamalı ST 37 çelikten oluşur. Kumlama ve solvent içermeyen çinko astar kaplama ve elektrostatik toz boya uygulaması, aşırı hava koşulları ve UV altında olarak korozyona dayanıklıdır.



UV resistant with high value of light fastness rotomolded polyethylene parts are used to form the structure. All parts are manufactured with double wall technique with the thickness between 4-6 mm.

Plastik parçalarda yüksek ışık haslığına sahip UV dayanımlı rotasyon tekniği ile üretilen polietilen bileşenler kullanılmaktadır. Tüm parçalar 4-6 mm arası kalınlıkta çift cidar tekniği ile imal edilmektedir.



Platforms are made of plastic-coated steel sheets which are decorated with drainage and holes. Plastic coating provides further protection against falls and weather conditions.

Platformlar plastik kaplı metal sacdan üretilmiş ve üzerinde drenaj delikleri bulunmaktadır. Plastik kaplama düşme durumlarında ve olumsuz hava koşullarına karşı ilave koruma sağlar.

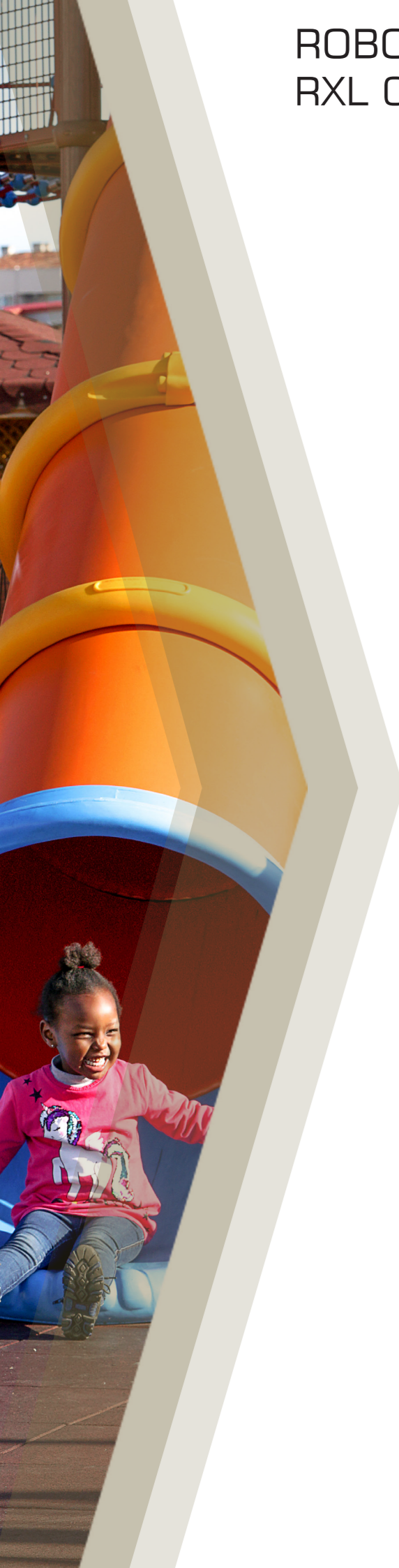

ROBOT SERIES
RXL 01

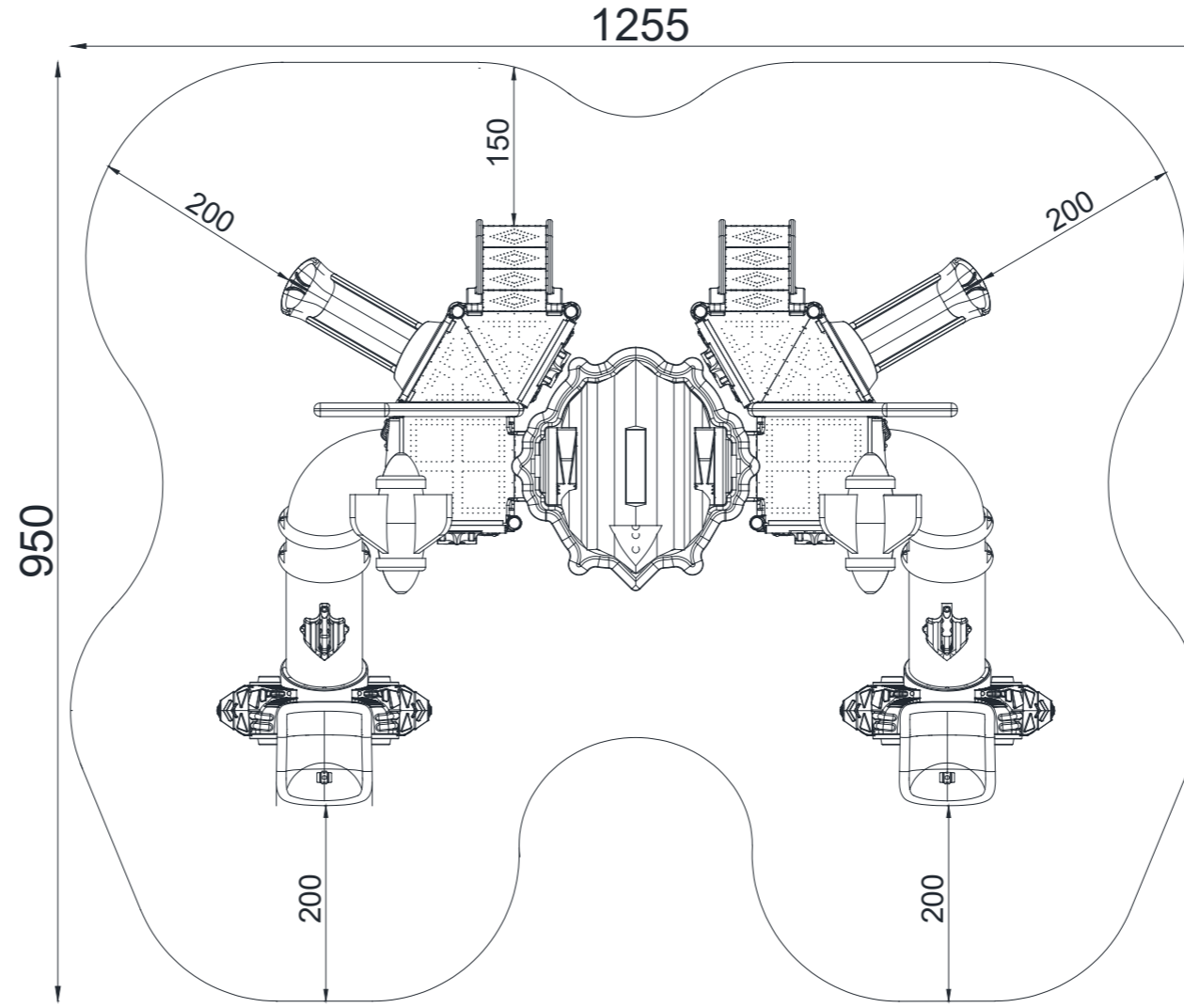

ÜST GÖRÜNÜŞ / **TOP VIEW**

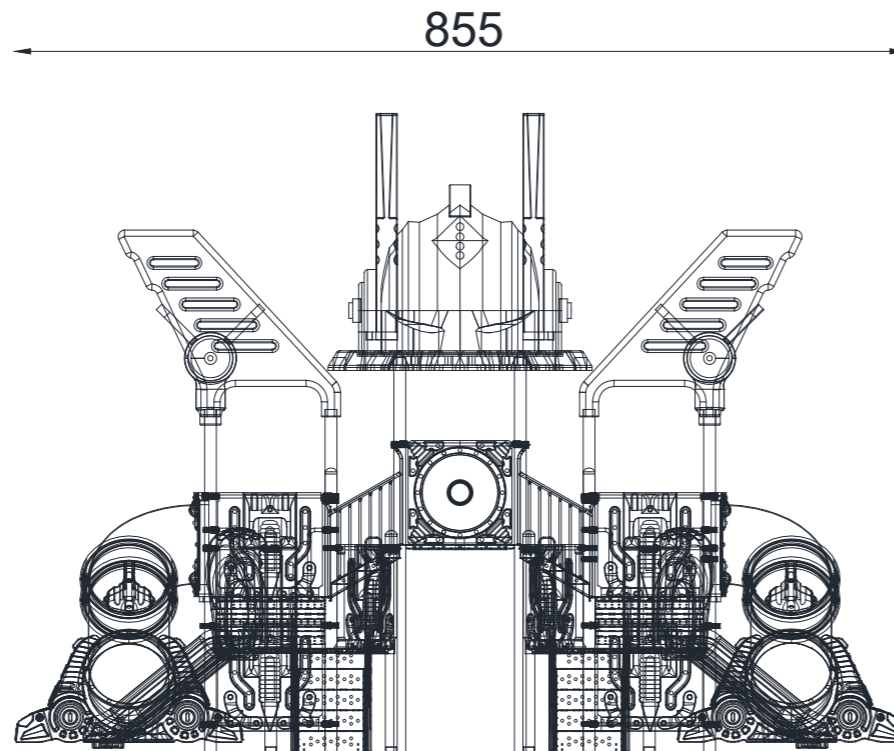

ÖN GÖRÜNÜŞ / **FRONT VIEW**

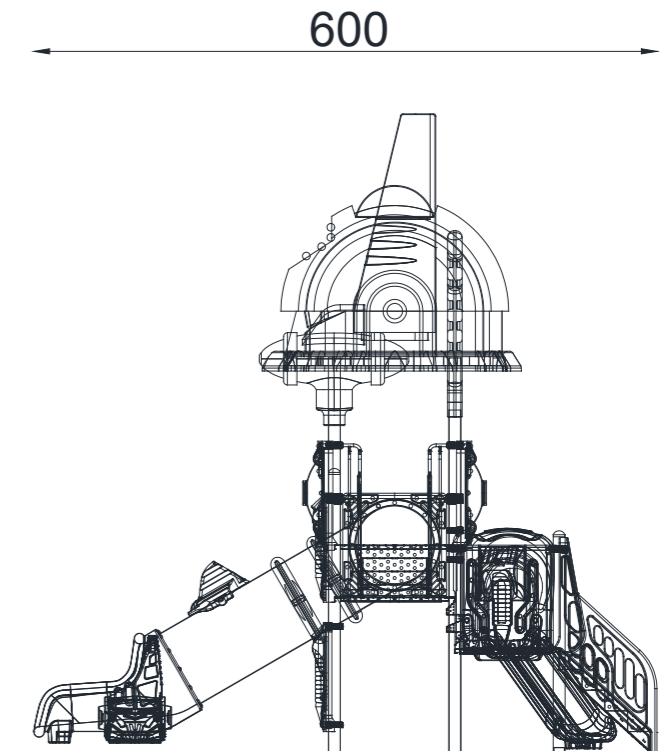

YAN GÖRÜNÜŞ / **SIDE VIEW**

*Maksimum Düşme Yüksekliği / **Maximum Fall Height** Gösterilen ölçüler cm cinsindedir / **Dimensions shown are in cm**

ROBOT SERIES

RXL 01



ZIPLAMA / **BOUNCING**

Zıplama; esnek, elastik veya gerili bir yüzey üzerinde zıplama eylemidir.

To bounce is the act of bouncing on a responsive, flexible, elastic or tensile surface.



KAYMA / **SLIDE**

Kayma; kaydırak üzerinden hızla aşağı doğru hareket etme eylemidir.

To slide is the act of moving fast downwards stead on a slide.



DENGE / **BALANCE**

Denge; zorlu yüzeylerde dik durma, ya da yürüme eylemidir.

To balance is to stay upright when walking or standing on a surface that makes this challenging.



SALINIM / **ROCK**

Salınım; yaylı vb bir ekipman üzerinde ileri geri veya yana sallanma eylemidir.

To rock is the action of rocking back and forth, or sideways, on e.g. a piece of spring equipment.



OTURMA / **SITTING**

Çocukların otururken hem dinlenebileceği hemde eğlenceli vakit geçirebileceği alandır.

It is an area where children can rest while sitting and have fun.



SALLANMA / **SWING**

Sallanma; otururken, ayakta ya da uzanarak ileri geri ya da dairesel hareket ile yay çizerek sallanma eylemidir.

To swing is the movement of swinging back forth, of in circular movement, seated, standing or lying, in a unhindered arc.



ASILMA / **HANGING**

Kollarla asılma; eller ve kollar ile vücudu taşıma ve diğer platform veya oyun gruplarına geçiş yapma eylemidir.

To hang in arms is the act of carrying the body with the hands or arms, possible to traverse to another platform or play item.



DÖNÜŞ / **SPIN**

Dönüş; sosyal etkileşimi kolaylaştıran bir oyun ekipmanı üzerinde vücudun yatay veya dikey olarak hızla döndürülmesini içerir.

To spin involves a fast, repeating horizontal or vertical turn of the body on a piece of equipment that facilitates social interaction.



TIRMANMA / **CLIMBING**

Tırmanma; eğimli ya da dikey yüzey ve ip ağlar üzerinde el ve ayak kaslarını koordine ederek kendini yukarı çıkarma eylemidir.

To climb is the act of moving upwards, cross coordinating arms and legs, on a vertical or inclined surface or net.



EMEKLEME / **CRAWLING**

Emekleme; düz ya da hafif eğimli yüzeylerde kol ve bacakları koordine ederek ileri ya da geri ilerleme hareketidir.

To crawl is the movement of moving forwards or backwards, cross - coordinating arms and legs, on a horizontal or slightly incline surface



KOŞMA / **RUNNING**

Koşma, çocukların oyun grubuyla etkileşime girerek koşmasını teşvik edecek şekilde fiziksel gelişim sağlama aktivitesidir.

Running is an activity that encourages children to interact with the playgroup by running and develop physically.



ENGELLI / **ACCESSIBLE**

Engelli çocukların engelsiz bir biçimde kendilerini farklı hissetmeden oynayabilecekleri özel alanlardır.

These are special areas where children with disabilities can play and have fun and without feeling different.



ETKİLEŞİM / **INTERACTION**

Çocukların dokunarak, hissederek oyun grubuyla etkileşime geçmesidir.

It is children's communicating with the play group by touching and feeling.



ÇEVİRME / **ROTATE**

Çevirme, vücudun bir ekipman yardımıyla dikey eksende veya daha yavaş tempoyla yatay eksende dönüşünü ifade eder.

To rotate involves a vertical or horizontal slower paced turn of the body, facilitated by a piece of equipment.



EŞİTLİK / **EQUALITY**

Eşitlik, cinsiyet farketmeksizin tüm çocukların ilgisini eşit miktarda çekme aktivitesidir.

Equality is the feature of the playgroup to attract the attention of all children, regardless of gender.



SOSYALLEŞME / **SOCIALIZE**

Sosyalleşme, sosyal etkileşimi teşvik eden ve kolaylaştıran bir faaliyet vasıtasıyla buluşma, iletişim kurma veya iş birliği yapma eylemidir.

To socialize is the act of meeting, communicating or cooperating in an activity that stimulates and facilitates social interaction.



ROL YAPMA / **ROLE PLAY**

Rol yapma, belirli rollere bürünmeyi ve rol yapmayı davet eden yer ve ortam öğeleri ile rol yaparak oynama teşvik edilir.

Role play is motivated through play items that stage a frame, place or environment for acting out make believe or role play scenarios.



ÇEKME / **PULL**

Çekme, bir nesneyi bir veya iki elinizle veya muhtemelen tüm vücudunuzla kendinize veya başka bir şeye doğru çekme eylemidir.

To pull is the act of pulling item towards you or you towards an item with one or both hands, or possibly with the entire body.



SÜZÜLME / **GLIDE**

Süzülme, bir noktadan diğerine oturarak, yatarak veya ayakta durur pozisyonda ayakları oynatmadan yatay veya dikey yönde yerçekimini kullanarak hareket etme eylemidir.

To glide is the act of moving from one point to another without shifting the feet, in a horizontal or vertical movement in a seated, lying or standing position, letting gravity do the work.



İTME / **PUSH**

İtme, bir öğeyi bir veya iki eliniz ile ya da tüm vücudunuz ile kendinizden uzağa itme eylemidir.

To push is the act of pushing an item away from you with one or both hands, possibly with the entire body.